

Build a High Voltage power supply by using the MC34063 Chip

This kit allows you to make a MC34063 based boost PSU, which can accept a 12V DC input and output ~210V DC for powering NIXIE tubes and others that require high voltage. It is a very common circuit, the key point is the selection of the Inductor and the Mosfet.

Please do **not** change any equipments of the circuit or you may not be able to get the target HV output or the module may work under the lower efficiency state.

For more info & update, please visit [HTTP://vfdclock.jimdo.com](http://vfdclock.jimdo.com)

Or contact us: zjjszhangf@gmail.com

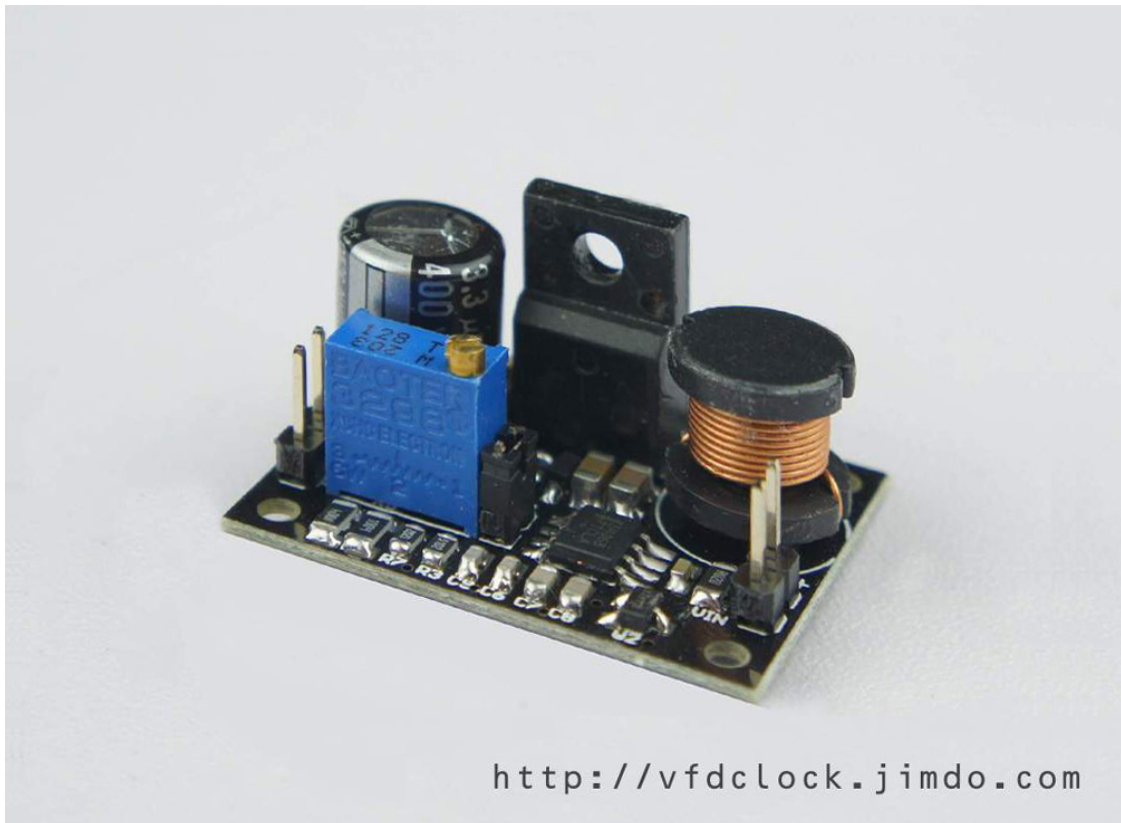

How it works

The circuit is very simple, we used one of the most common switching regulators on the planet-the MC34063 chip. The circuit is based on the Step-up structure. MC34063 contains a NPN output only structure, in order to drive the Mosfet, we add a 1K pull-down resistor(R2) to get the low side signal. And because we need to convert the 12V DC input to the ~210V DC output in one step, the ration requirement is very high, so we add a speed up circuit by using a PNP transistor(Q3) and a schottky diode(D2) to speed up the drop side of the driving wave. And in the current version, we added a ration jumper (X1), by connecting the different capacitors together, you can change

the frequency of the circuit in High/Low levels, when the jumper shorted, you get lower frequency, which can get more higher ration, and more higher DC output even under heavy loader, but the efficiency of the circuit may have a little bit drop. Other part of the circuit is very simple, please check the MC34063 official PDF file by yourself.

Building it

Well, because of the circuit is pretty simple, all you need to do is get all the components in the right position and make sure no short before you plug the power. And the kit contains SMD components, so you must have the skills of soldering the SMD stuff. We will show the soldering steps and the matters needing attention blow.

1. Please print out the PCB installation diagram by yourself, the Circuit diagram is no need for soldering job, print it or not depends on you;
2. Check all the components in the kit bag, make sure nothing is missing (You can do it on a A4 white copy paper);
3. We recommend using a soldering station and small soldering tip for soldering this kit (we use F2 or CF2 type tip). If you have a hot air gun for soldering, that will be great. we recommend using $\sim 180^{\circ}\text{C}$ soldering tin for this job. Please do not use the high temperature soldering tin in this project, you may damage a lot of SMD components;

Step 1:

Solder right-bottom part first, this part contains a R020 1206 resistor, a SOT-23 PMOSFET (X7HV), a 100nF/50V capacitor, and 3 frequency capacitor under the bottom (100pF/390pF/68pF), this step is very simple, just make sure the direction of the IC, do not go invert.

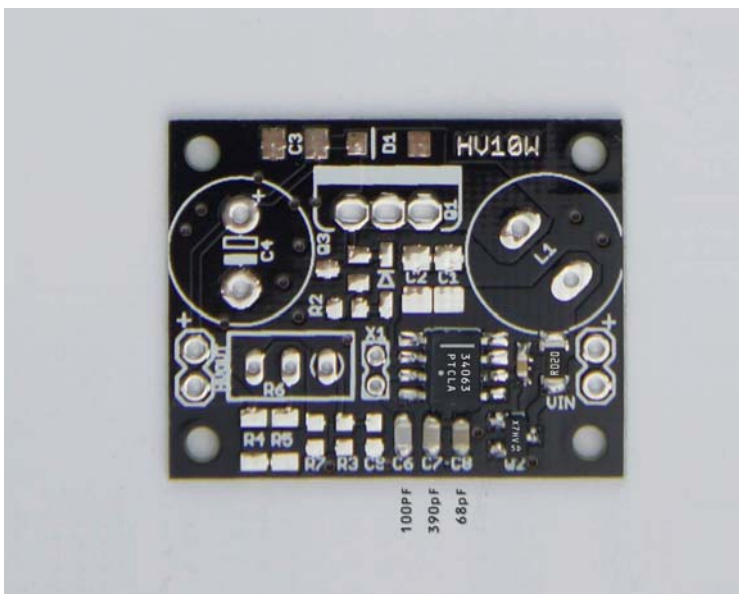

Step 2:

Solder the middle-right 2PCS 100uF/50V input capacitors (C1, C2 in 1206 package). These two capacitors are important part of the circuit, please solder carefully, use low temperature with no over 250°C and solder fast, or you will lost the capacity or damage the capacitor. If possible, you can solder 3PCS of the cap by just solder the last one on the top of the other capacitor to get 300uF input capacity. (Note: Solder 2PCS 100uF cap at least, do not just solder 1PCS)

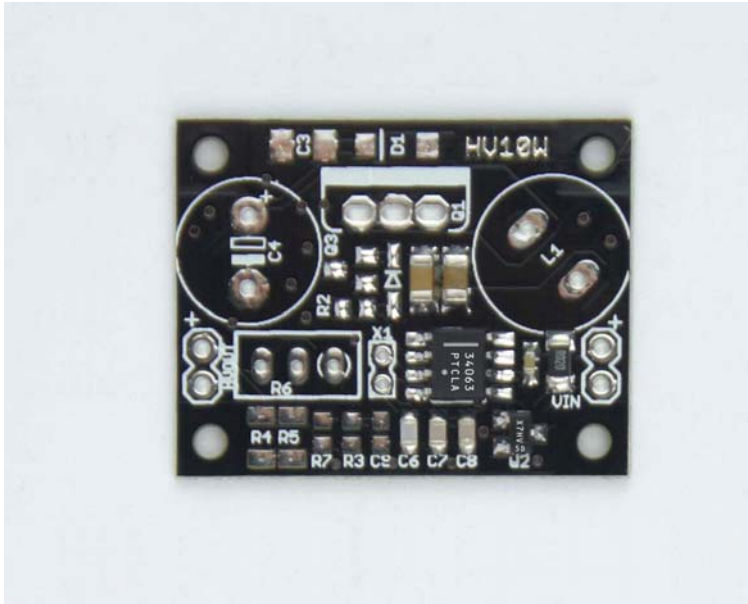

Step 3:

Solder the middle-left part, it contains R2, Q3 and D2 (a IN4148 diode), those part are easy, just make sure the direction of the IN4148 diode is right, please check the picture blow.

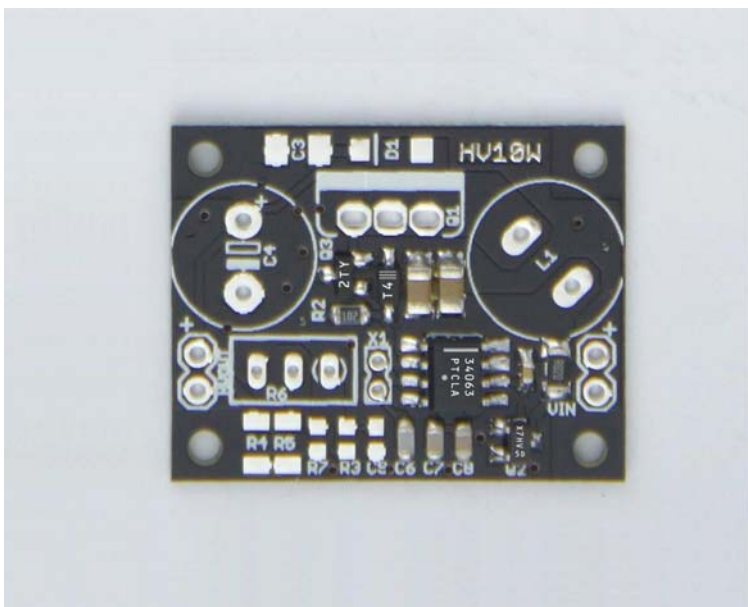

Step 4:

Solder the top edge part, it contains C3 and D1, the C3 is a 0u1F/500V capacitor in 1206 package, if mixed with the 100uF capacitor that we used in the step 2, you can just measure the capacity by yourself, easy to find out. Also the D1 is the diode (usually be ES1J diode), take care of the direction too.

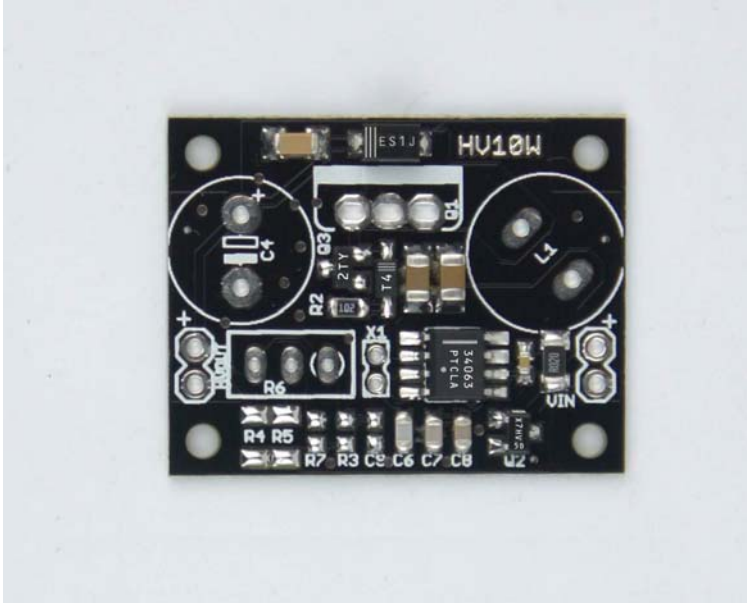

Step 5:

Solder the bottom-left part, it contains R4,R5,R7,R3,C6, the R7 and R5 are two 1M resistor in 1206 package, they are connected in serial in the circuit and been placed pretty close on the PCB, so please do short it. the R7(12K resistor in 0805/0603 package) is required for the HV feedback. the R3(51K resistor in 0805/0603 package) is for safety of the feed back circuit, please install it, and the C6(100pF/50V capacitor) is optional , we recommend you install it.

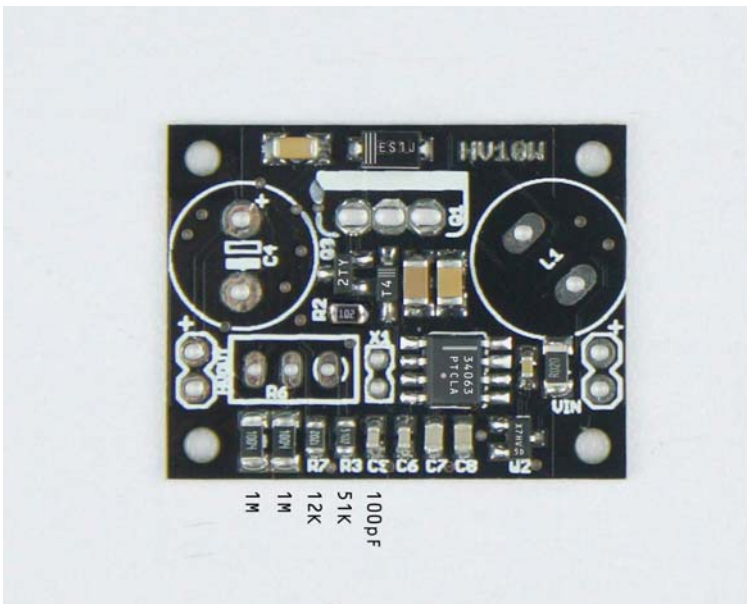

Step 6:

From step1~step5, we have finished soldering all the SMD parts of the circuit. Before we solder the DIP parts of the circuit, we can check the PCB and wash it first, after the PCB dried, you can cover it by using Plasticote (like CRC 70), or just escape this step.

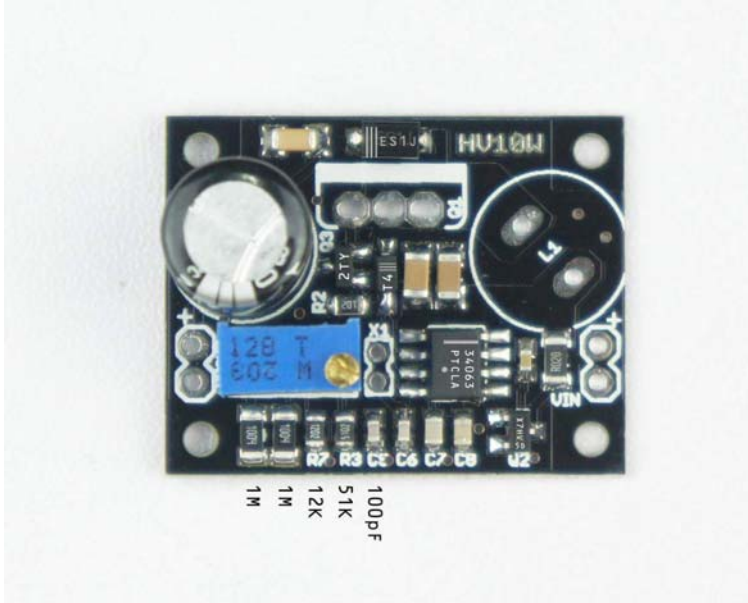

Step 7:

Soldering all the DIP part of the circuit. The dip part contains L1, Q1, C4, R6, X1, PTH-IN, PTH-OUT, those are easy part, just take care of the C4 (HV Aluminum Electrolytic Capacitor), it has polarity, do not install it in invert direction. And for the main HV mosfet (Q1), if the mosfet in the kit is the TO220 package, you just need to plug it in the place, then cut the legs short and solder it, if the package is the TO263 package, band left&right legs straight by using needle-nose pliers or other tools.

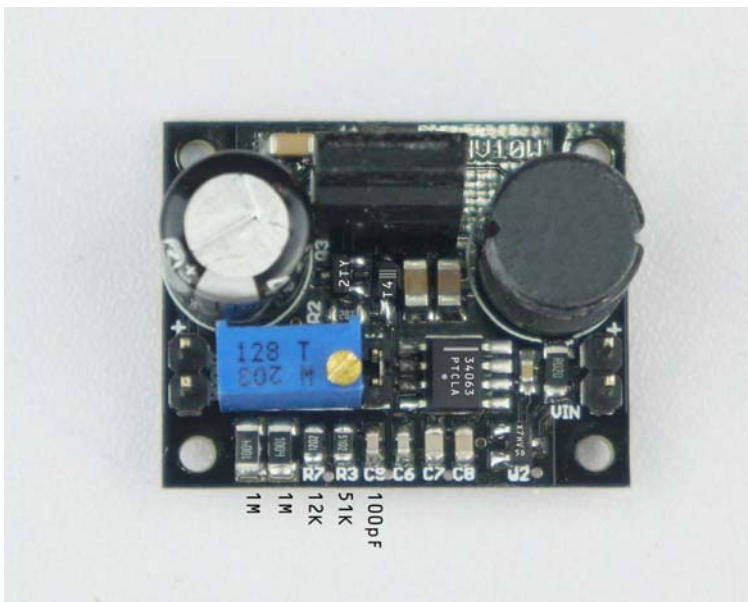

The mosfet's mark surface must be face the frond side of the PCB(face the MC34063 chip side).Double check the mosfet part after soldering, make sure it contains no short, it is very important!

The smoke test

Put the circuit board on an insulating surface, connect no loader to the output side, connect the input pin to a 9~12V DC source. If you have a current limited supply that will be perfect. Or you can try to use a 9V small home using MN1604 (6LF22) battery to prevent to burn something at the first time.

If all fine, the max output usually can go up to ~210V with no problem.
The whole circuit is pretty easy, no need to adjust.

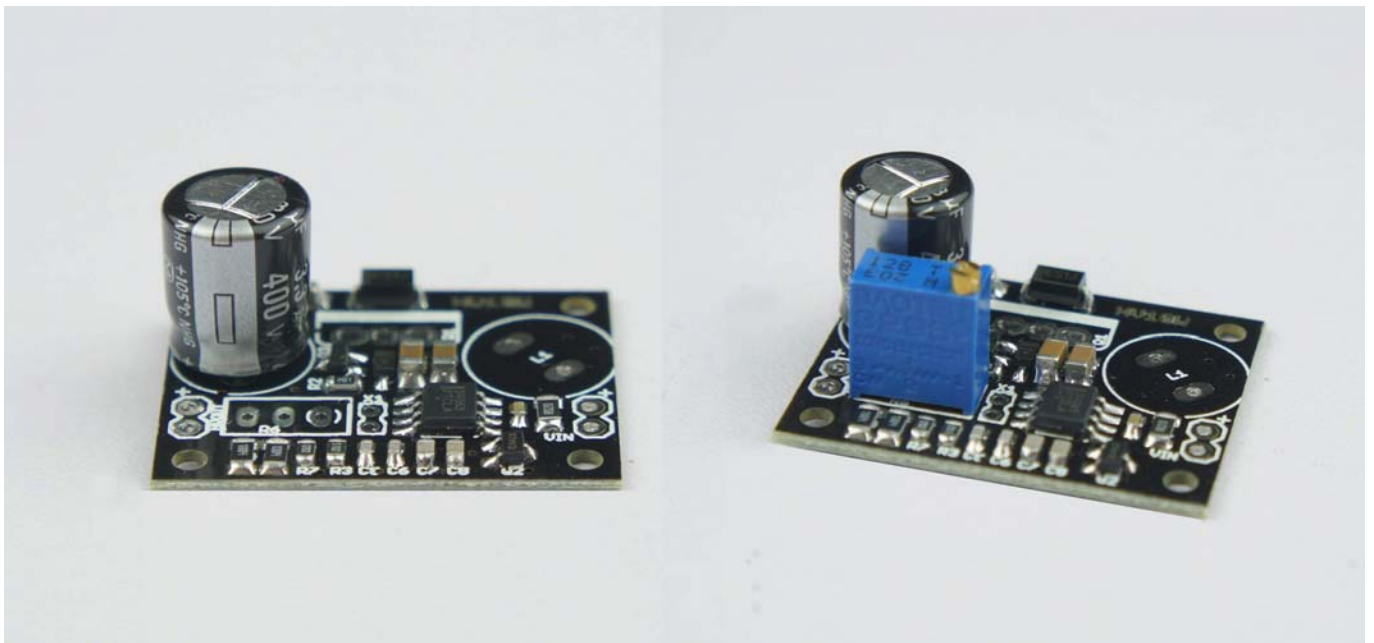

Identifying the parts of your power supply kit

The following guide should help you to identify the parts and assemble it successfully

Resistors

All the resistors contains mark on one side of it's surface.

Diode

The diodes will be marked with ES1J(big one) and T4(the small one), the cathode side contains a few vertical line.

Capacitors

Kit contains two type of the 1206 size capacitors, one is 0u1/500V, the other is 100uF/50V, easy to find out by measure it. Other small size of the capacitors will have the make on the surface of its' package. And for the Aluminum Electrolytic Capacitor, usually the longer lead is positive, or if both leads are the same, the negative is clearly marked with a big line or minus symbol running down the side of the case.

The MOSFET

The MOSFET will be marked 27N25 or other numbers, please note the mosfet marks surface must be installed face to the MC34063 chip side.

The MC34063 chip

MC34063 chip in this kit is SO8 package, make sure it is installed the correct way around, just follow the chip direction shown on the picture.

Partlist

Assembly variant:

Qty	Value	Device	Parts	Mark
Resistors				
1	R020	RESISTOR_EUR1206	R1	R020
2	1M	RESISTOR_EUR1206	R4, R5	1004
1	1k	RESISTOR_EUR0603/0805	R2	102
1	12k	RESISTOR_EUR0603/0805	R7	1202
1	51k	RESISTOR_EUR0603/0805	R3	5102
1	20k	R-TRIMM3296W	R6	203
Capacitor				
1	68pF	C-EUC0603/0805	C8	/
2	100pF	C-EUC0603/0805	C6, C9	/
1	390pF	C-EUC0603/0805	C7	/
1	0u1	C-EUC0603/0805	C5	/
2	100uF/50V	C-EUC1206	C1, C2	/
1	0u1/500V	C-EUC1206	C3	/
Diode				
1	ES1J	DIODE-SMA	D1	ES1J
1	T4	DIODE-SCHOTTKYSOD123	D2	T4
Trans/Mosfet/IC				
1	X7HV	P-OSFET	Q2	X7HV-5D
1	8550	PNP	Q3	2TY
1	34063	MC34063-SO8	IC1	34063PTCLA.
PTH/Jumper				
2	2.54mm	PTH M02PTH	HVOUT, VIN	/
1	2mm	PTH 87758-0216	X1	/
1	2mm	Jumper		/
Others				
1	100uH	INDUCTANCE_US11X11PLUG	L1-100UH	/
1	Mosfet	MOSFET-NCHANNELTO220V-BH2	Q1	/
1	3.3uF/400V	CPOL-EUE5-10.5	C4	3.3uF 400V
PCB				
1	PCB			

exported from MC34063HV-02D-KIT

Contents

How it works	1
Building it	2
Step 1:	2
Step 2:	3
Step 3:	3
Step 4:	4
Step 5:	4
Step 6:	5
Step 7:	5
The smoke test	6
Identifying the parts of your power supply kit	7
Partlist	8

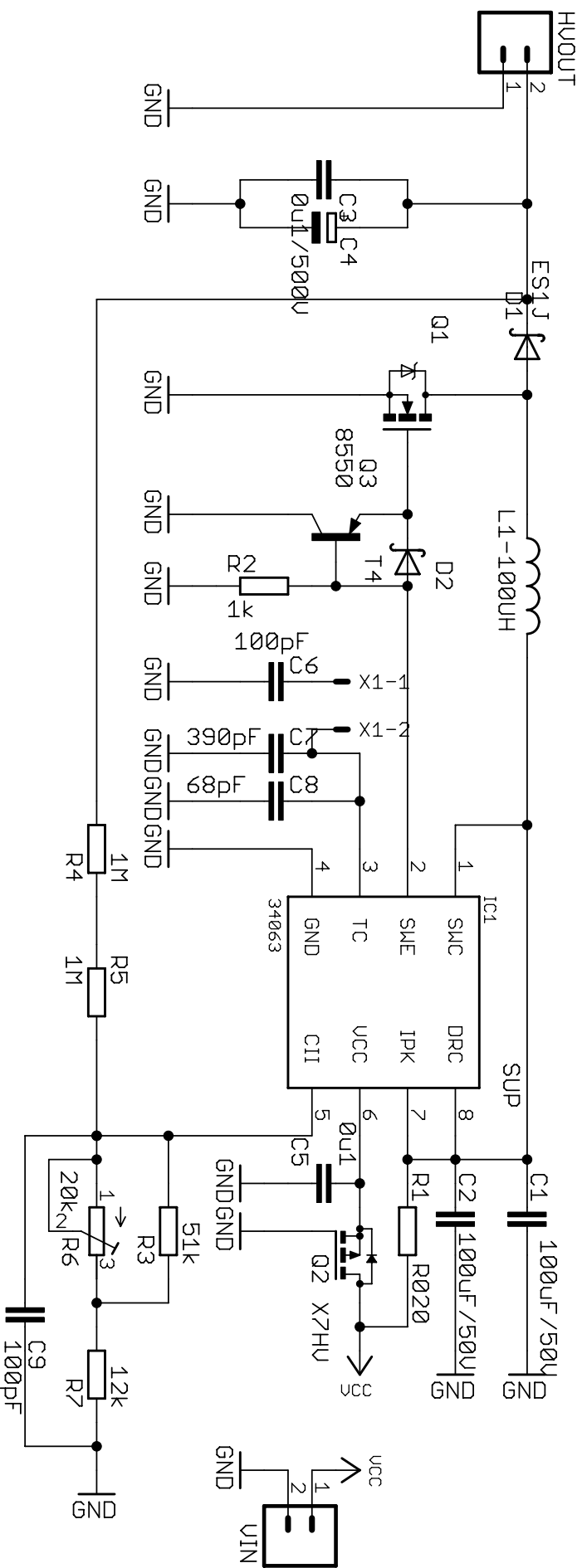

HU10M-MC34063 V1.3

0L1/500V | ES1J HV10W

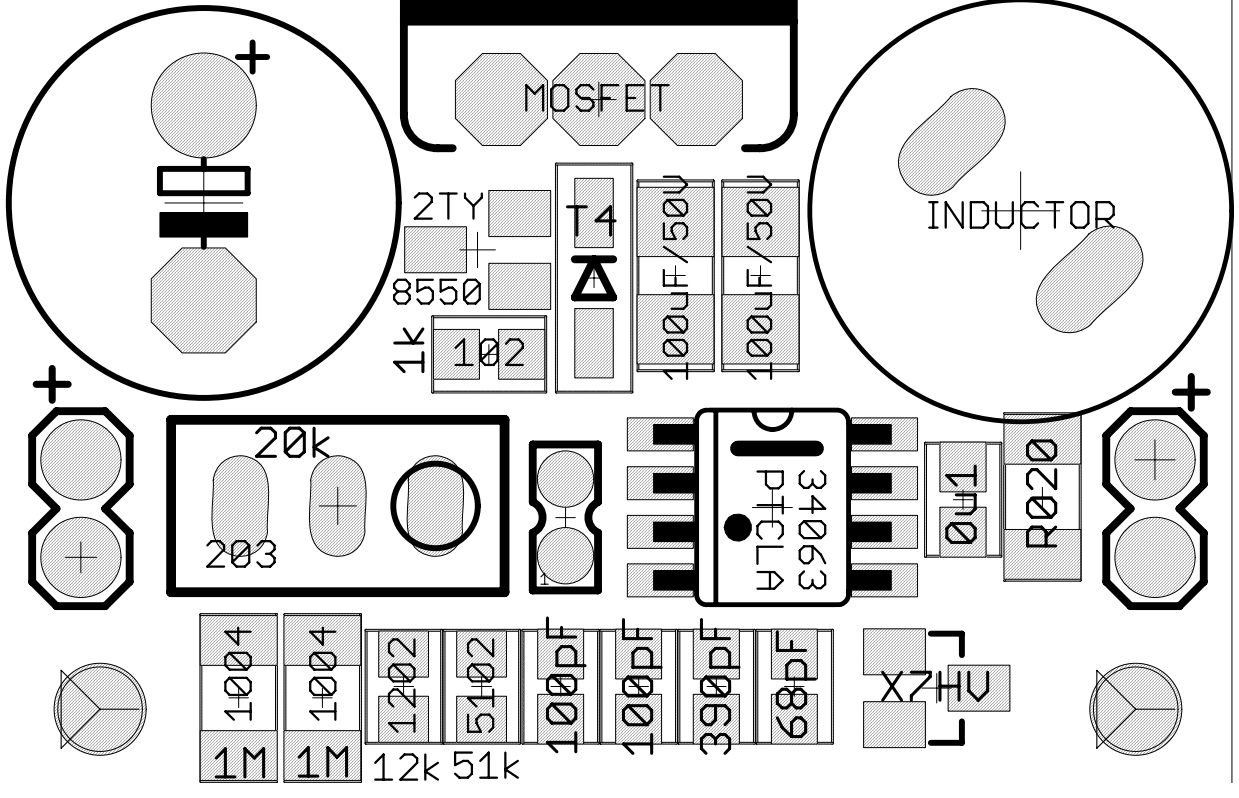

C3 | D1 HV10W

